

# Electroweak corrections for the LHC

Marek Schönherr

Universität Zürich

Göttingen, 03/06/2016



Universität  
Zürich<sup>UZH</sup>



FONDS NATIONAL SUISSE  
SCHWEIZERISCHER NATIONALFONDS  
FONDO NAZIONALE SVIZZERO  
SWISS NATIONAL SCIENCE FOUNDATION

## Introduction

Electroweak correction come in two variants: virtual corrections and real emission correction.

Virtual electroweak corrections often studied in the context of jet production at large transverse momentum (EW-Sudakov suppression). Usually negative and rising with  $p_{\perp}$ .

Real electroweak corrections usually constitute a separate process. However, largest BR of  $W/Z$  bosons is hadronic, thus (almost) indistinguishable in jet production. Nonetheless may constitute signal in itself.

When large scale differences occur resummation is needed in either case. Practically at LHC13/14 these scale differences are moderate.

# Outline

- 1 Next-to-leading order electroweak corrections
  - Tools and setup
  - Selected results
- 2 Electroweak effects in multijet merging
  - QCD multijet merging
  - Inclusion of electroweak corrections
- 3 Real boson radiation
  - Resummation via EW parton showers
  - Case study: Finding  $W$  bosons inside jets
- 4 Conclusions

# Electroweak corrections for LHC physics

- 1 Next-to-leading order electroweak corrections
  - Tools and setup
  - Selected results
- 2 Electroweak effects in multijet merging
  - QCD multijet merging
  - Inclusion of electroweak corrections
- 3 Real boson radiation
  - Resummation via EW parton showers
  - Case study: Finding  $W$  bosons inside jets
- 4 Conclusions

# Consistent setup: counting orders and defining signatures

tree configuration

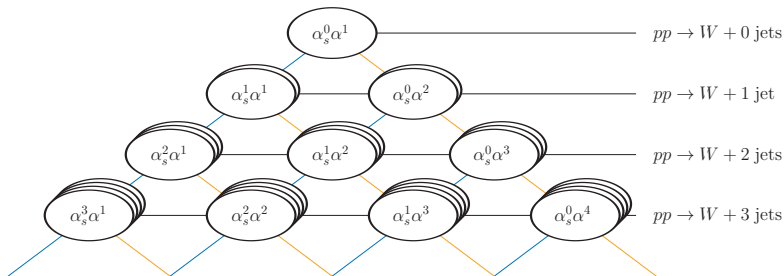

- NLO QCD:  $\alpha_s^1 = 1$  parton, only MEs from squared diagrams
- NLO EW:  $\alpha^1 = 1$  photon

# Consistent setup: counting orders and defining signatures

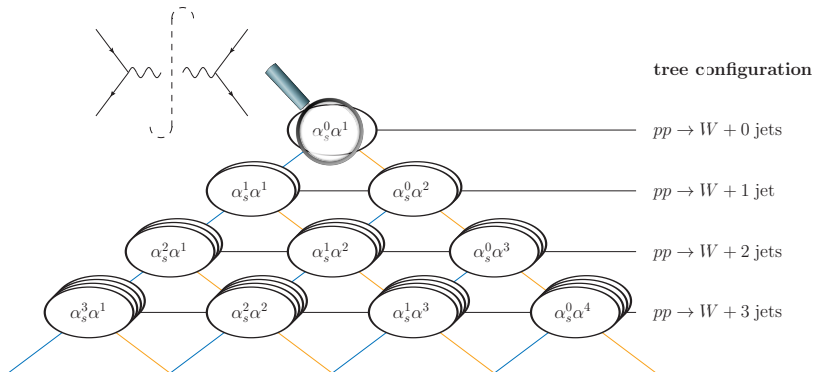

- NLO QCD:  $\alpha_s^1 = 1$  parton, only MEs from squared diagrams
- NLO EW:  $\alpha^1 = 1$  photon

# Consistent setup: counting orders and defining signatures

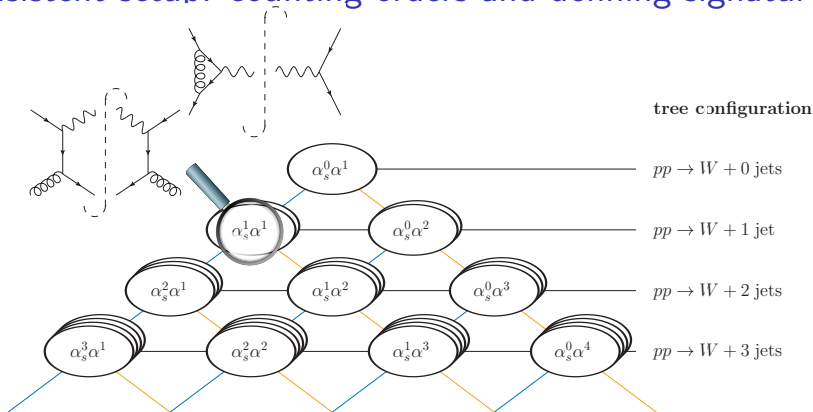

- NLO QCD:  $\alpha_s^1 = 1$  parton, only MEs from squared diagrams
- NLO EW:  $\alpha^1 = 1$  photon

# Consistent setup: counting orders and defining signatures

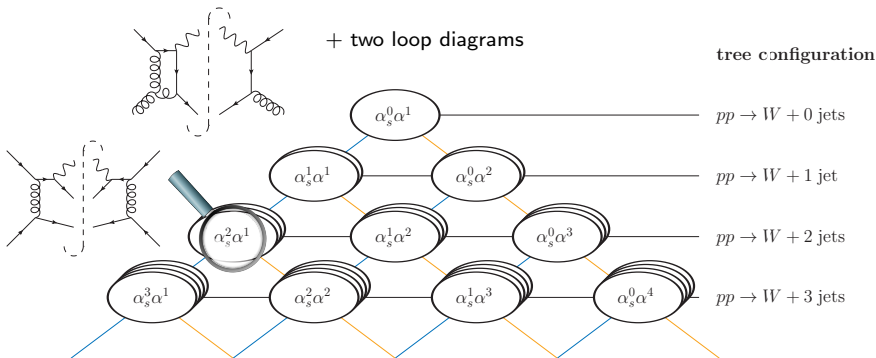

- NLO QCD:  $\alpha_s^1 = 1$  parton, only MEs from squared diagrams
- NLO EW:  $\alpha^1 = 1$  photon

# Consistent setup: counting orders and defining signatures

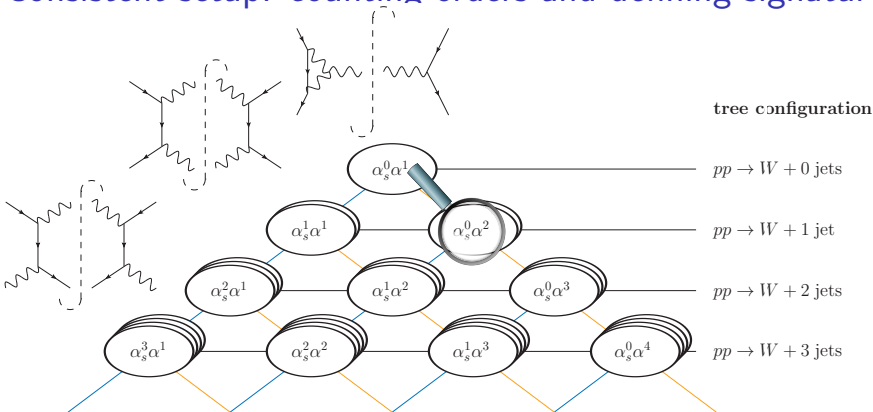

- NLO QCD:  $\alpha_s^1 = 1$  parton, only MEs from squared diagrams
- NLO EW:  $\alpha^1 = 1$  photon or 1 parton

also MEs from interfering  $\mathcal{O}(g_s^{n\pm 1} e^{m\mp 1})$  diagrams, resonances



## Consistent setup: counting orders and defining signatures

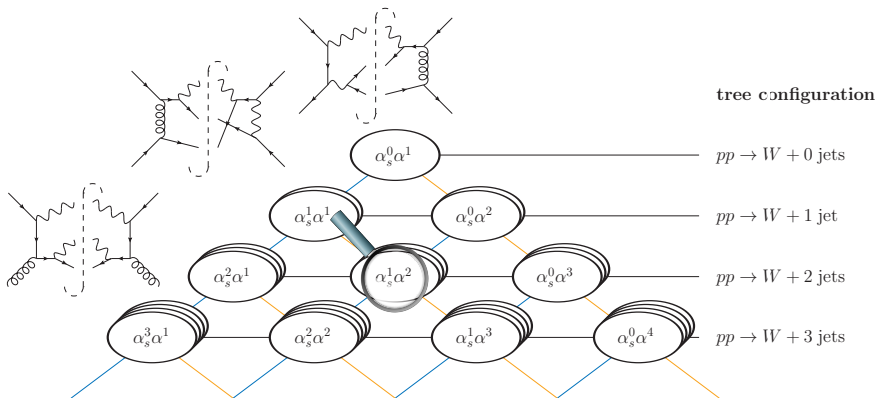

- NLO QCD:  $\alpha_s^1 = 1$  parton, only MEs from squared diagrams
- NLO EW:  $\alpha^1 = 1$  photon or 1 parton  
also MEs from interfering  $\mathcal{O}(g_s^{n\pm 1} e^{m\mp 1})$  diagrams

# Consistent setup: counting orders and defining signatures

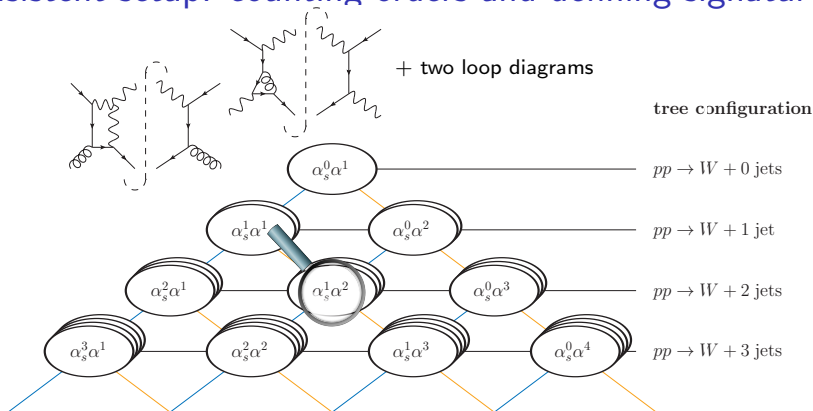

- NLO QCD:  $\alpha_s^1 = 1$  parton, only MEs from squared diagrams
- NLO EW:  $\alpha^1 = 1$  photon or 1 parton  
also MEs from interfering  $\mathcal{O}(g_s^{n\pm 1} e^{m\mp 1})$  diagrams, resonances

# Consistent setup: counting orders and defining signatures

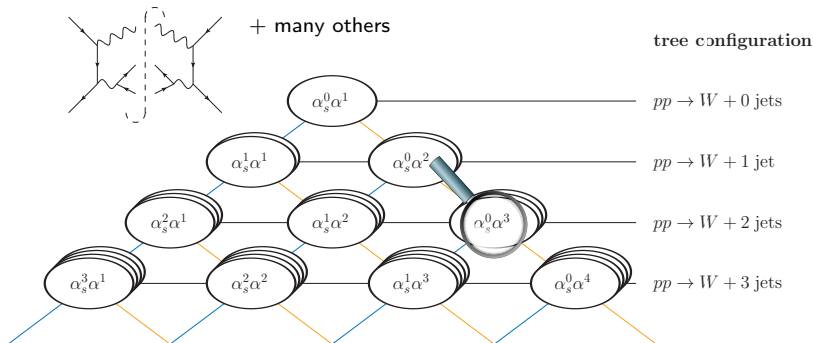

- NLO QCD:  $\alpha_s^1 = 1$  parton, only MEs from squared diagrams
- NLO EW:  $\alpha^1 = 1$  photon or 1 parton  
also MEs from interfering  $\mathcal{O}(g_s^{n\pm 1} e^{m\mp 1})$  diagrams, resonances

# Tools and setup

Kallweit, Lindert, Maierhöfer, Pozzorini, MS JHEP04(2015)012, JHEP04(2016)021

- fixed-order next-to-leading order electroweak corrections to on-/off-shell  $pp \rightarrow V + 1, 2(, 3)$  jets production
- OPENLOOPS for virtual corrections using COLLIER for tensor integrals
- SHERPA for Born, real em., subtraction and phase space integration, MUNICH (MEs from OPENLOOPS) for subtraction and p. s. int.
- combine QCD and EW to leading  $pp \rightarrow V + 1, 2(, 3)$  process in two schemes

$$\text{QCD+EW: } \sigma_{\text{NLO QCD+EW}} = \sigma_{\text{LO}} (1 + \delta_{\text{QCD}} + \delta_{\text{EW}})$$

$$\text{QCD} \times \text{EW: } \sigma_{\text{NLO QCD} \times \text{EW}} = \sigma_{\text{LO}} (1 + \delta_{\text{QCD}}) (1 + \delta_{\text{EW}})$$

- dress quarks and leptons in  $\Delta R = 0.1$ ,  
if  $\gamma$  in jet,  $E_\gamma < \frac{1}{2} E_{\text{jet}}$ , discard jet otherwise
- use NNPDF2.3QED with LO QED PDF  
ideally would need NLO QED PDF



# NLO EW subtraction in SHERPA

MS in preparation

- adapt QCD subtraction (spl. fns. and colour-/spin-correlated MEs)  
Catani, Dittmaier, Seymour, Trocsanyi Nucl.Phys.B627(2002)189-265

- replacements:  $\alpha_s \rightarrow \alpha$ ,  $C_F \rightarrow Q_f^2$ ,  $C_A \rightarrow 0$ ,  
 $T_R \rightarrow N_{c,f} Q_f^2$ ,  $n_f T_R \rightarrow \sum_f N_{c,f} Q_f^2$ ,  
 $\frac{\mathbf{T}_{ij} \cdot \mathbf{T}_k}{\mathbf{T}_{ij}^2} \rightarrow \frac{Q_{ij} Q_k}{Q_{ij}^2}$

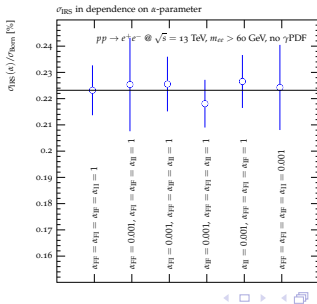
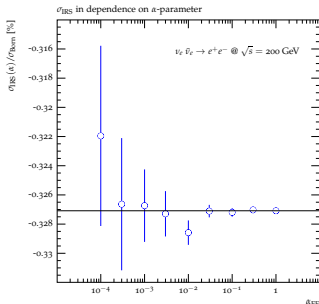



# NLO EW subtraction in SHERPA

MS in preparation

- adapt QCD subtraction (spl. fns. and colour-/spin-correlated MEs)  
Catani, Dittmaier, Seymour, Trocsanyi Nucl.Phys.B627(2002)189-265

- replacements:  $\alpha_s \rightarrow \alpha$ ,  $C_F \rightarrow Q_f^2$ ,  $C_A \rightarrow 0$ ,  
 $T_R \rightarrow N_{c,f} Q_f^2$ ,  $n_f T_R \rightarrow \sum_f N_{c,f} Q_f^2$ ,  
 $\frac{\mathbf{T}_{ij} \cdot \mathbf{T}_k}{\mathbf{T}_{ij}^2} \rightarrow \frac{Q_{ij} Q_k}{Q_{ij}^2}$

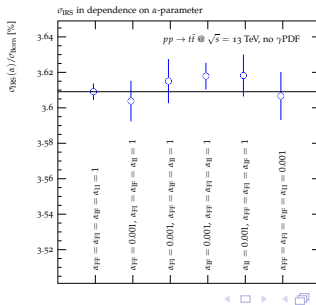
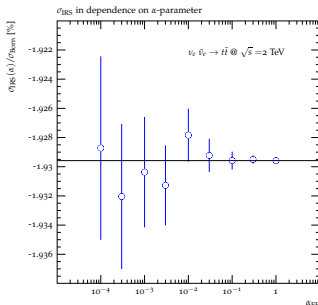



# NLO EW subtraction in SHERPA

MS in preparation

- adapt QCD subtraction (spl. fns. and colour-/spin-correlated MEs)

Catani, Dittmaier, Seymour, Trocsanyi Nucl.Phys.B627(2002)189-265

- replacements:  $\alpha_s \rightarrow \alpha$ ,  $C_F \rightarrow Q_f^2$ ,  $C_A \rightarrow 0$ ,  
 $T_R \rightarrow N_{c,f} Q_f^2$ ,  $n_f T_R \rightarrow \sum_f N_{c,f} Q_f^2$ ,

$$\frac{\mathbf{T}_{ij} \cdot \mathbf{T}_k}{\mathbf{T}_{ij}^2} \rightarrow \frac{Q_{ij} Q_k}{Q_{ij}^2}$$

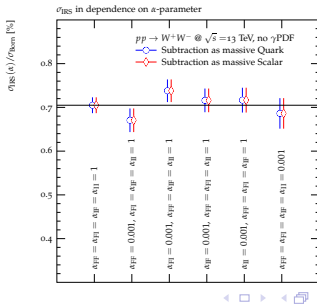
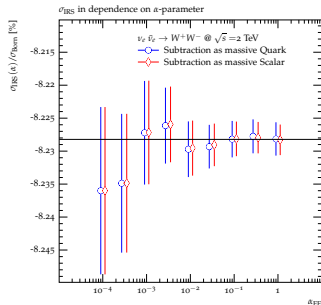

$pp \rightarrow Wj @ 13 \text{ TeV}$ 

Kallweit, Lindert, Maierhöfer, Pozzorini, MS JHEP04(2016)021

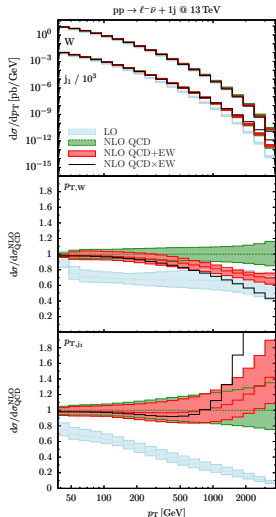

- NLO QCD to  $p_T^j$  dominated by hard dijet topologies  
→ LO, no EW corr.

Rubin, Salam, Sapeta  
JHEP09(2010)084

→ need merging

- remove dijet configs through  $\Delta\phi_{j_1 j_2} < \frac{3}{4}\pi$   
→ EW Sudakov recovered

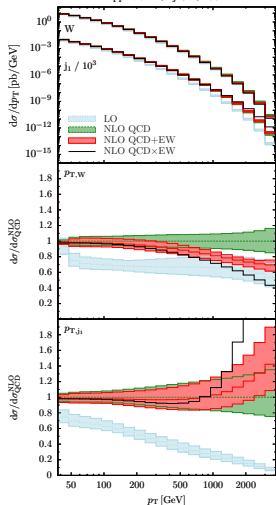
$pp \rightarrow Wj @ 13 \text{ TeV}$  $pp \rightarrow \ell^- \bar{\nu} + 1j @ 13 \text{ TeV}$ 

Kallweit, Lindert, Maierhöfer, Pozzorini, MS JHEP04(2016)021

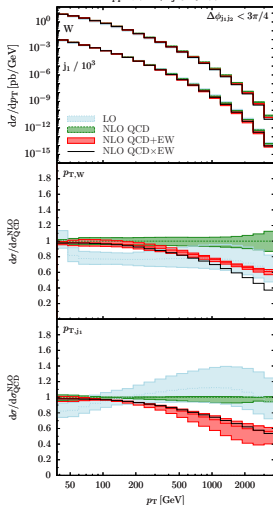
 $pp \rightarrow \ell^- \bar{\nu} + 1j @ 13 \text{ TeV}$ 

- NLO QCD to  $p_T^j$  dominated by hard dijet topologies  
→ LO, no EW corr.

Rubin, Salam, Sapeta  
JHEP09(2010)084

→ need merging

- remove dijet configs through  $\Delta\phi_{j_1 j_2} < \frac{3}{4}\pi$   
→ EW Sudakov recovered

$pp \rightarrow Wjj @ 13 \text{ TeV}$ 

Kallweit, Lindert, Maierhöfer, Pozzorini, MS JHEP04(2016)021

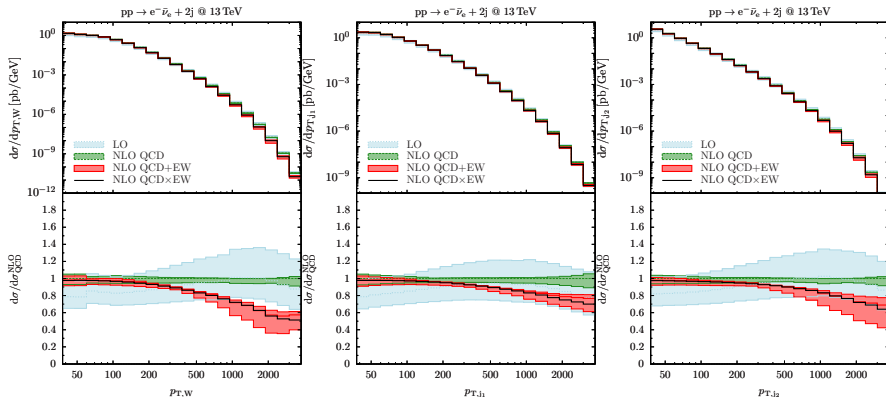

$pp \rightarrow Zjj @ 13 \text{ TeV}$ 

Kallweit, Lindert, Maierhöfer, Pozzorini, MS JHEP04(2016)021

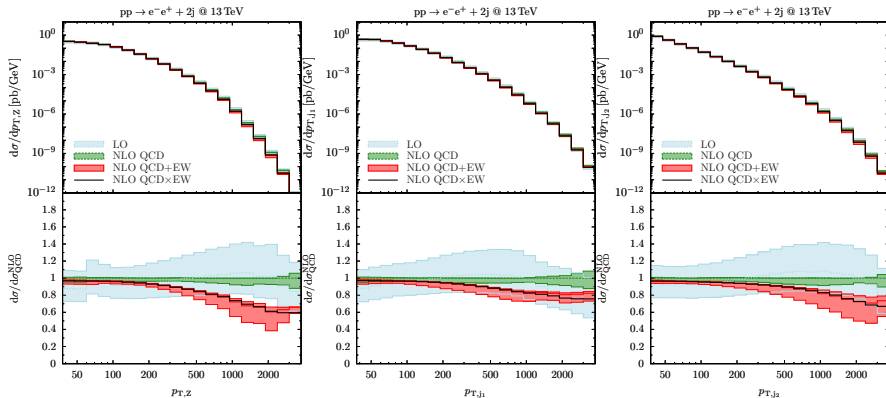



# $pp \rightarrow Zjj @ 13 \text{ TeV}$

Kallweit, Lindert, Maierhöfer, Pozzorini, MS JHEP04(2016)021

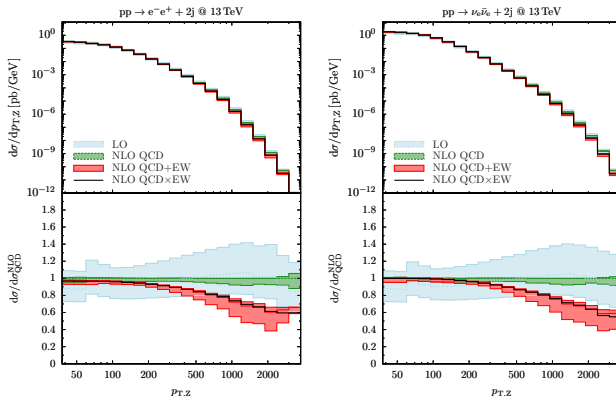

→ EW corrections independent of the decay mode



# $Z/\gamma$ ratio @ 8 TeV

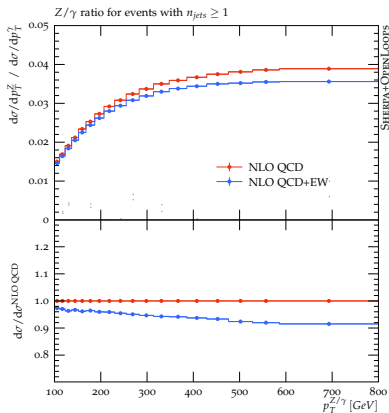

Kallweit, Lindert, Pozzorini, MS for LH'15

- use this ratio to get handle on  $p_{\perp}^Z$  in  $Z \rightarrow \nu\bar{\nu}$  for NP searches
- test how well data is described in  $Z \rightarrow \ell\ell$
- ⇒ NLO EW improves data description



# $Z/\gamma$ ratio @ 8 TeV

Kallweit, Lindert, Pozzorini, MS for LH'15

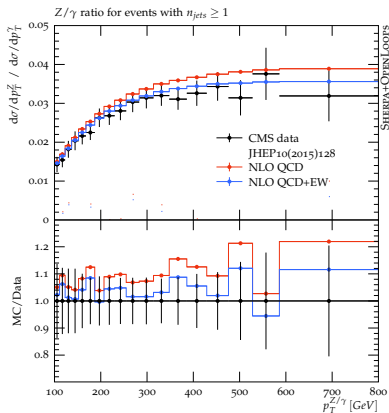

- use this ratio to get handle on  $p_\perp^Z$  in  $Z \rightarrow \nu\bar{\nu}$  for NP searches
  - test how well data is described in  $Z \rightarrow \ell\ell$
- ⇒ NLO EW improves data description



# $pp \rightarrow 2l2\nu @ 13 \text{ TeV}$

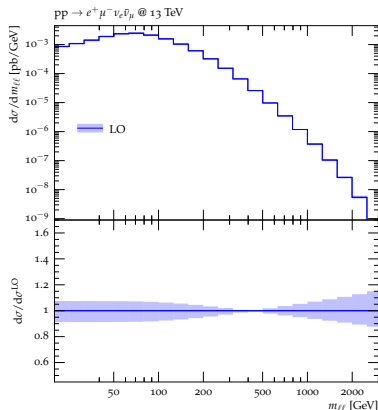

Kallweit, Lindert, Pozzorini, MS in prep.

## $pp \rightarrow e^+ \mu^- \nu_e \bar{\nu}_\mu @ 13 \text{ TeV}$

- $\mu = H_T^{\text{lep}} = \sum_{i \in \{e, \mu\}} p_{\perp, i} + \cancel{E}_T$

- analyses impose jet veto to control  $t\bar{t}$ -background  
→ also reduces QCD corr.
- usual behaviour of NLO EW
- $\gamma$ -induced LO large at high- $x$
- $\gamma$ PDF dependence huge

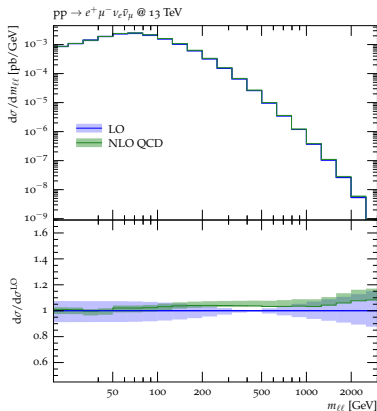
$pp \rightarrow 2l2\nu @ 13 \text{ TeV}$ 

Kallweit, Lindert, Pozzorini, MS in prep.

 $pp \rightarrow e^+ \mu^- \nu_e \bar{\nu}_\mu @ 13 \text{ TeV}$ 

- $\mu = H_T^{\text{lep}} = \sum_{i \in \{e, \mu\}} p_{\perp, i} + \cancel{E}_T$

- analyses impose jet veto to control  $t\bar{t}$ -background  
→ also reduces QCD corr.

- usual behaviour of NLO EW
- $\gamma$ -induced LO large at high- $x$
- $\gamma$ PDF dependence huge

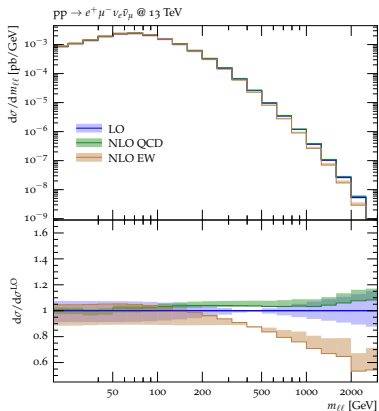
$pp \rightarrow 2l2\nu @ 13 \text{ TeV}$ 

Kallweit, Lindert, Pozzorini, MS in prep.

 $pp \rightarrow e^+ \mu^- \nu_e \bar{\nu}_\mu @ 13 \text{ TeV}$ 

- $\mu = H_T^{\text{lep}} = \sum_{i \in \{e, \mu\}} p_{\perp, i} + \cancel{E}_T$
- analyses impose jet veto to control  $t\bar{t}$ -background  
→ also reduces QCD corr.
- usual behaviour of NLO EW
  - $\gamma$ -induced LO large at high- $x$
  - $\gamma$ PDF dependence huge

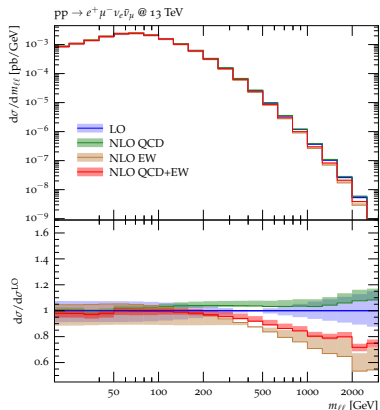
$pp \rightarrow 2l2\nu @ 13 \text{ TeV}$ 

Kallweit, Lindert, Pozzorini, MS in prep.

 $pp \rightarrow e^+ \mu^- \nu_e \bar{\nu}_\mu @ 13 \text{ TeV}$ 

- $\mu = H_T^{\text{lep}} = \sum_{i \in \{e, \mu\}} p_{\perp, i} + \cancel{E}_T$
- analyses impose jet veto to control  $t\bar{t}$ -background  
→ also reduces QCD corr.
- usual behaviour of NLO EW
  - $\gamma$ -induced LO large at high- $x$
  - $\gamma$ PDF dependence huge



# $pp \rightarrow 2\ell 2\nu @ 13 \text{ TeV}$

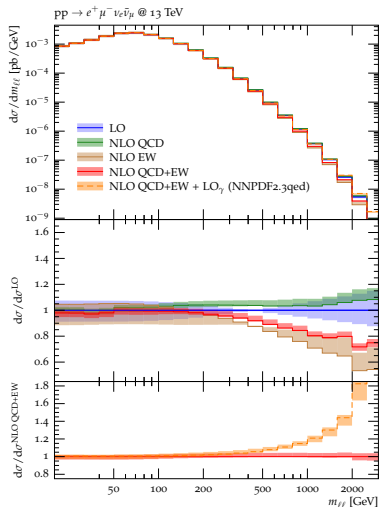

Kallweit, Lindert, Pozzorini, MS in prep.

## $pp \rightarrow e^+ \mu^- \nu_e \bar{\nu}_\mu @ 13 \text{ TeV}$

- $\mu = H_T^{\text{lep}} = \sum_{i \in \{e, \mu\}} p_{\perp, i} + \cancel{E}_T$
- analyses impose jet veto to control  $t\bar{t}$ -background  
→ also reduces QCD corr.
- usual behaviour of NLO EW
- $\gamma$ -induced LO large at high- $x$
- $\gamma$ PDF dependence huge



# $pp \rightarrow 2\ell 2\nu @ 13 \text{ TeV}$

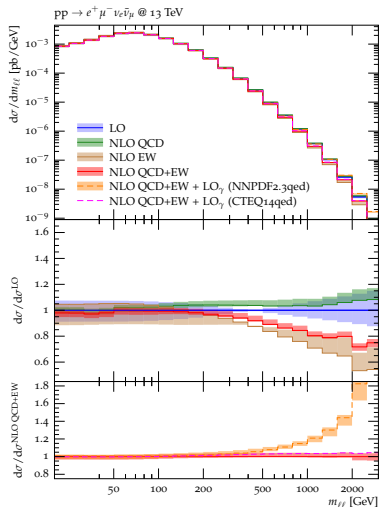

Kallweit, Lindert, Pozzorini, MS in prep.

## $pp \rightarrow e^+ \mu^- \nu_e \bar{\nu}_\mu @ 13 \text{ TeV}$

- $\mu = H_T^{\text{lep}} = \sum_{i \in \{e, \mu\}} p_{\perp, i} + \cancel{E}_T$
- analyses impose jet veto to control  $t\bar{t}$ -background  
→ also reduces QCD corr.
- usual behaviour of NLO EW
- $\gamma$ -induced LO large at high- $x$
- $\gamma$ PDF dependence huge  
similar in all obs.  
→ ideal to measure  $\gamma$ PDF



# $pp \rightarrow 2\ell 2\nu @ 13 \text{ TeV}$

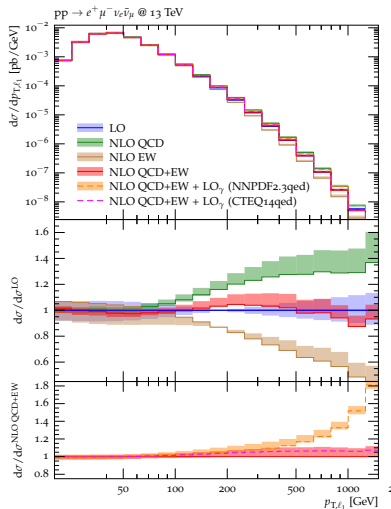

Kallweit, Lindert, Pozzorini, MS in prep.

## $pp \rightarrow e^+ \mu^- \nu_e \bar{\nu}_\mu @ 13 \text{ TeV}$

- $\mu = H_T^{\text{lep}} = \sum_{i \in \{e, \mu\}} p_{\perp, i} + \cancel{E}_T$
- analyses impose jet veto to control  $t\bar{t}$ -background  
→ also reduces QCD corr.
- usual behaviour of NLO EW
- $\gamma$ -induced LO large at high- $x$
- $\gamma$ PDF dependence huge  
similar in all obs.  
→ ideal to measure  $\gamma$ PDF

$pp \rightarrow h \ell \nu @ 100 \text{ TeV}$ 

Kallweit, Lindert, Pozzorini, MS for FCC report

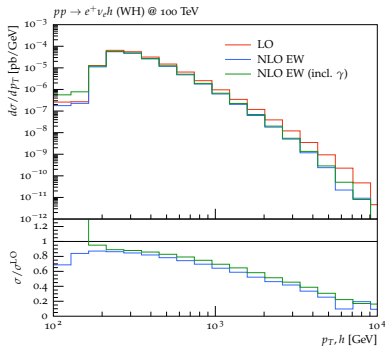
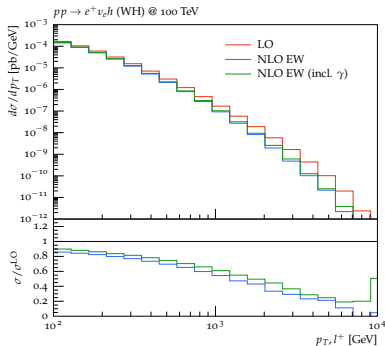

- moderate impact of photon induced channels, no shape change
- likely large  $\gamma$ PDF uncertainty

# Electroweak corrections for LHC physics

- 1 Next-to-leading order electroweak corrections
  - Tools and setup
  - Selected results
- 2 Electroweak effects in multijet merging
  - QCD multijet merging
  - Inclusion of electroweak corrections
- 3 Real boson radiation
  - Resummation via EW parton showers
  - Case study: Finding  $W$  bosons inside jets
- 4 Conclusions

# QCD multijet merging – LO case

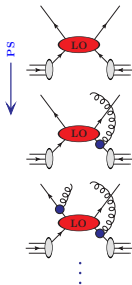

## Parton showers

resummation of (soft-)collinear limit  
→ intrajet evolution

- matrix elements (ME) and parton showers (PS) are approximations in different regions of phase space
- MEPS combines multiple LOPS – keeping either accuracy
- NLOPS elevate LOPS to NLO accuracy
- MENLOPS supplements core NLOPS with higher multiplicities LOPS

## QCD multijet merging – LO case

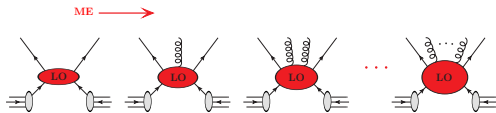

### Matrix elements

fixed-order in  $\alpha_s$

→ hard wide-angle emissions

→ interference terms

- matrix elements (ME) and parton showers (PS) are approximations in different regions of phase space
  - MEPS combines multiple LOPS – keeping either accuracy
  - NLOPS elevate LOPS to NLO accuracy
  - MENLOPS supplements core NLOPS with higher multiplicities LOPS

# QCD multijet merging – LO case

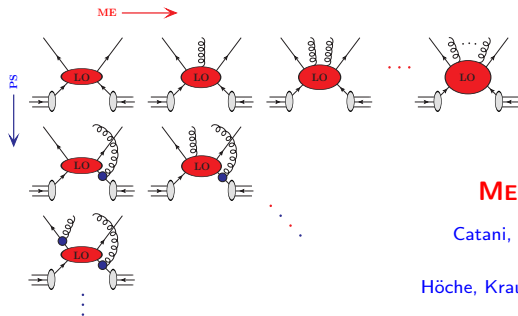

**MEPS** (CKKW, MLM)

Catani, Krauss, Kuhn, Webber JHEP11(2001)063

Lönnblad JHEP05(2002)046

Höche, Krauss, Schumann, Siebert JHEP05(2009)053

- matrix elements (ME) and parton showers (PS) are approximations in different regions of phase space
- MEPS combines multiple LOPS – keeping either accuracy
  - NLOPS elevate LOPS to NLO accuracy
  - MENLOPS supplements core NLOPS with higher multiplicities LOPS

# QCD multijet merging – NLO case

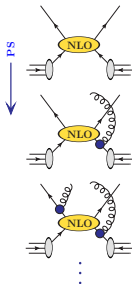

**NLOs** (MC@NLO, POWHEG)

Frixione, Webber JHEP06(2002)029

Nason JHEP11(2004)040, Frixione et.al. JHEP11(2007)070

Höche, Krauss, MS, Siegert JHEP09(2012)049

- matrix elements (ME) and parton showers (PS) are approximations in different regions of phase space
- MEPS combines multiple LOPs – keeping either accuracy
- NLOs elevate LOPs to NLO accuracy

• MENLOPS supplements core NLOs with higher multiplicities LOPs

# QCD multijet merging – NLO case

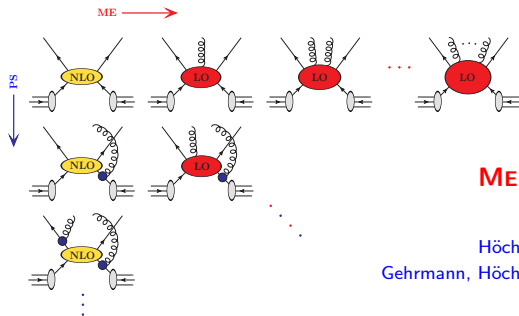

**MENLOPS**

Hamilton, Nason JHEP06(2010)039

Höche, Krauss, MS, Siebert JHEP08(2011)123

Gehrmann, Höche, Krauss, MS, Siebert JHEP01(2013)144

- matrix elements (ME) and parton showers (PS) are approximations in different regions of phase space
- MEPS combines multiple LOPs – keeping either accuracy
- NLOPS elevate LOPs to NLO accuracy
- MENLOPS supplements core NLOPS with higher multiplicities LOPs

# QCD multijet merging – NLO case

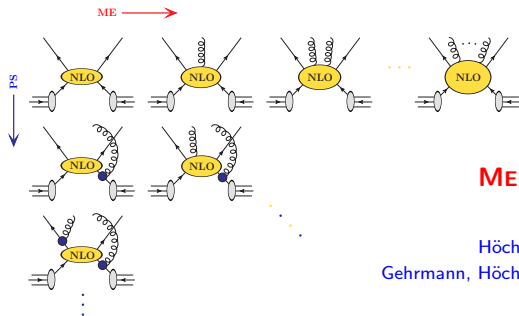

**MEPS@NLO**

Lavesson, Lönnblad JHEP12(2008)070

Höche, Krauss, MS, Siebert JHEP04(2013)027

Gehrmann, Höche, Krauss, MS, Siebert JHEP01(2013)144

Lönnblad, Prestel JHEP03(2013)166

Plätzer JHEP08(2013)114

- matrix elements (ME) and parton showers (PS) are approximations in different regions of phase space
- MEPS combines multiple LOPS – keeping either accuracy
- NLOPS elevate LOPS to NLO accuracy
- MENLOPS supplements core NLOPS with higher multiplicities LOPS
- MEPS@NLO combines multiple NLOPS – keeping either accuracy

## QCD multijet merging – NLO case

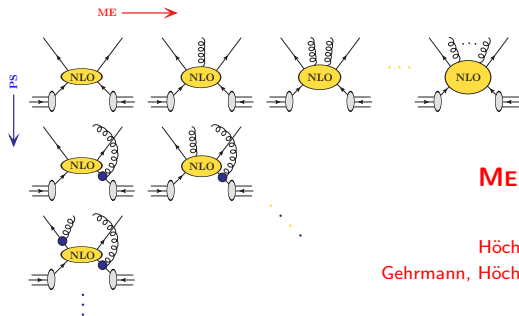

## MEPS@NLO

Lavesson, Lönnblad JHEP12(2008)070

Höche, Krauss, MS, Siebert JHEP04(2013)027

Gehrmann, Höche, Krauss, MS, Siebert JHEP01(2013)144

Lönnblad, Prestel JHEP03(2013)166

Plätzer JHEP08(2013)114

- matrix elements (ME) and parton showers (PS) are approximations in different regions of phase space
- MEPS combines multiple LOPS – keeping either accuracy
- NLOPS elevate LOPS to NLO accuracy
- MENLOPS supplements core NLOPS with higher multiplicities LOPS
- **MEPS@NLO** combines multiple NLOPS – keeping either accuracy

## MEPs@NLO

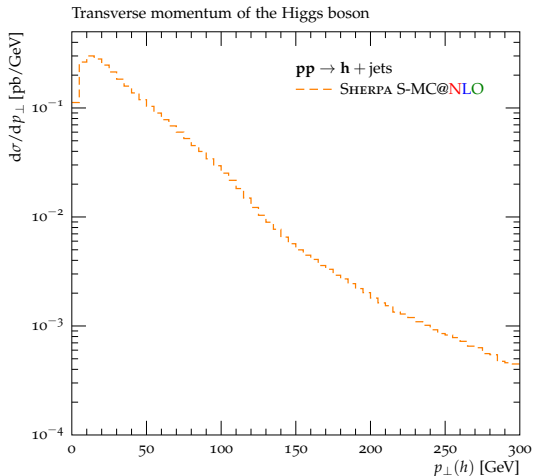

- first emission by NLOPS, restrict to  $Q_1 < Q_{\text{cut}}$
- NLOPS  $pp \rightarrow h + \text{jet}$  for  $Q_1 > Q_{\text{cut}}$
- restrict emission off  $pp \rightarrow h + \text{jet}$  to  $Q_2 < Q_{\text{cut}}$
- NLOPS  $pp \rightarrow h + 2\text{jets}$  for  $Q_2 > Q_{\text{cut}}$
- iterate
- sum all contribs

## MEPs@NLO

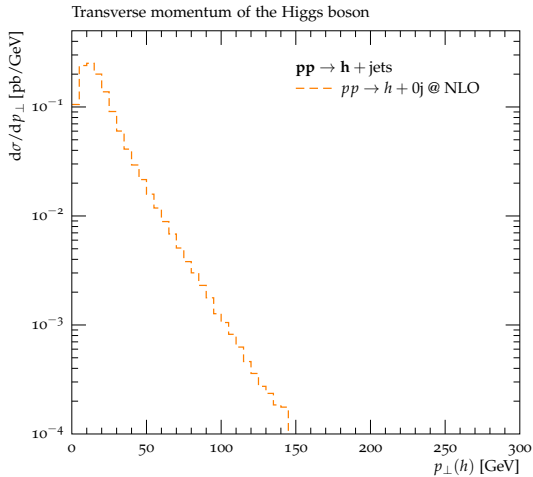

- first emission by NLOPS, restrict to  $Q_1 < Q_{\text{cut}}$
- NLOPS  
 $pp \rightarrow h + \text{jet}$  for  $Q_1 > Q_{\text{cut}}$
- restrict emission off  $pp \rightarrow h + \text{jet}$  to  $Q_2 < Q_{\text{cut}}$
- NLOPS  
 $pp \rightarrow h + 2\text{jets}$  for  $Q_2 > Q_{\text{cut}}$
- iterate
- sum all contribs

## MEPs@NLO

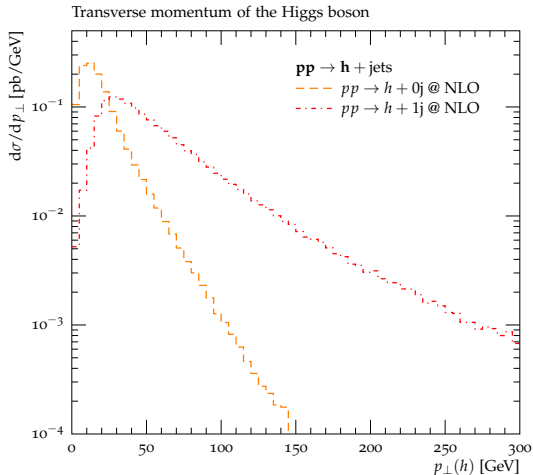

- first emission by NLOPS, restrict to  $Q_1 < Q_{\text{cut}}$

- NLOPS  $pp \rightarrow h + \text{jet}$  for  $Q_1 > Q_{\text{cut}}$

- restrict emission off  $pp \rightarrow h + \text{jet}$  to  $Q_2 < Q_{\text{cut}}$

- NLOPS  $pp \rightarrow h + 2\text{jets}$  for  $Q_2 > Q_{\text{cut}}$

- iterate

- sum all contribs

## MEPs@NLO

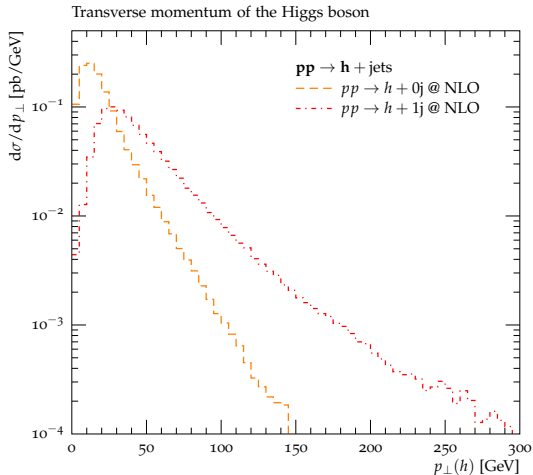

- first emission by NLOPS, restrict to  $Q_1 < Q_{\text{cut}}$
- NLOPS  $pp \rightarrow h + \text{jet}$  for  $Q_1 > Q_{\text{cut}}$
- restrict emission off  $pp \rightarrow h + \text{jet}$  to  $Q_2 < Q_{\text{cut}}$
- NLOPS  $pp \rightarrow h + 2\text{jets}$  for  $Q_2 > Q_{\text{cut}}$
- iterate
- sum all contribs

## MEPs@NLO

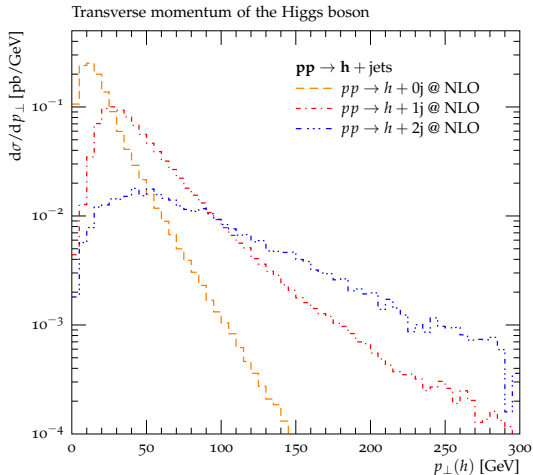

- first emission by NLOPS, restrict to  $Q_1 < Q_{\text{cut}}$
- NLOPS  $pp \rightarrow h + \text{jet}$  for  $Q_1 > Q_{\text{cut}}$
- restrict emission off  $pp \rightarrow h + \text{jet}$  to  $Q_2 < Q_{\text{cut}}$
- NLOPS  $pp \rightarrow h + 2\text{jets}$  for  $Q_2 > Q_{\text{cut}}$
- iterate
- sum all contribs

## MEPs@NLO

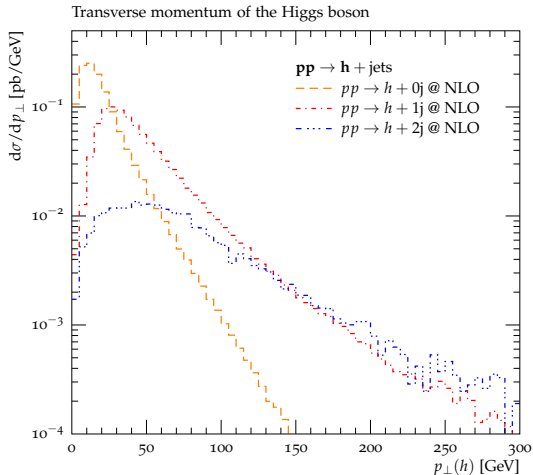

- first emission by NLOPS, restrict to  $Q_1 < Q_{\text{cut}}$
- NLOPS  $pp \rightarrow h + \text{jet}$  for  $Q_1 > Q_{\text{cut}}$
- restrict emission off  $pp \rightarrow h + \text{jet}$  to  $Q_2 < Q_{\text{cut}}$
- NLOPS  $pp \rightarrow h + 2\text{jets}$  for  $Q_2 > Q_{\text{cut}}$
- iterate
- sum all contribs

## MEPs@NLO

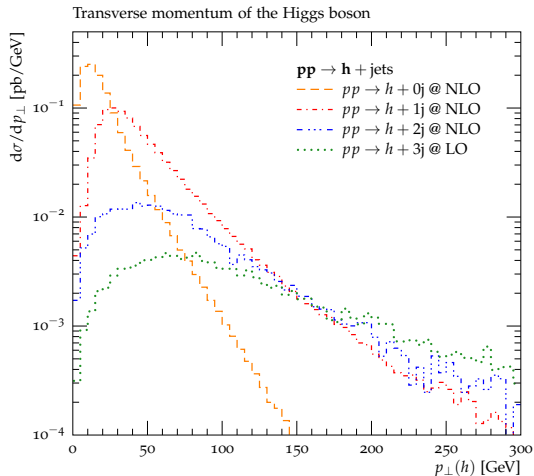

- first emission by NLOPS, restrict to  $Q_1 < Q_{\text{cut}}$
- NLOPS  $pp \rightarrow h + \text{jet}$  for  $Q_1 > Q_{\text{cut}}$
- restrict emission off  $pp \rightarrow h + \text{jet}$  to  $Q_2 < Q_{\text{cut}}$
- NLOPS  $pp \rightarrow h + 2\text{jets}$  for  $Q_2 > Q_{\text{cut}}$
- iterate
- sum all contribs

## MEPs@NLO

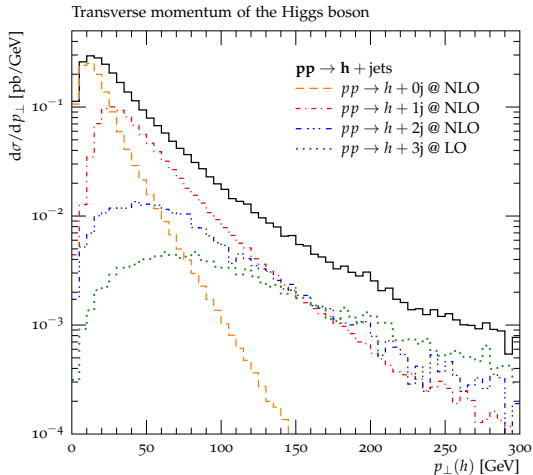

- first emission by NLOPS, restrict to  $Q_1 < Q_{\text{cut}}$
- NLOPS  $pp \rightarrow h + \text{jet}$  for  $Q_1 > Q_{\text{cut}}$
- restrict emission off  $pp \rightarrow h + \text{jet}$  to  $Q_2 < Q_{\text{cut}}$
- NLOPS  $pp \rightarrow h + 2\text{jets}$  for  $Q_2 > Q_{\text{cut}}$
- iterate
- sum all contribs

# QCD multijet merging – identifying a history

## Example: Drell-Yan production in association with jets

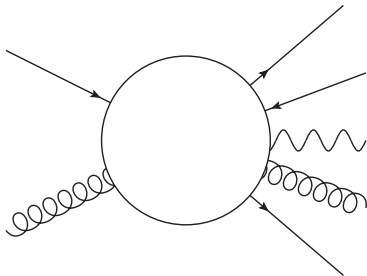

- cluster external particles using inverse parton shower → flavour conscious, initial state aware, probability determined through splitting kernels
- identify a shower history (probabilistically), determine scale  $t_i$  up to predefined  $t_l$
- choose

$$\alpha_s^{n+k}(\mu_R^2) = \alpha_s^k(\mu_{\text{core}}^2) \prod_{i=1}^n \alpha_s(t_i)$$

# QCD multijet merging – identifying a history

## Example: Drell-Yan production in association with jets

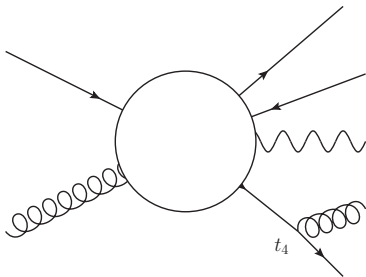

- cluster external particles using inverse parton shower → flavour conscious, initial state aware, probability determined through splitting kernels
- identify a shower history (probabilistically), determine scale  $t_i$  up to predefined  $t_i$
- choose

$$\alpha_s^{n+k}(\mu_R^2) = \alpha_s^k(\mu_{\text{core}}^2) \prod_{i=1}^n \alpha_s(t_i)$$

# QCD multijet merging – identifying a history

## Example: Drell-Yan production in association with jets

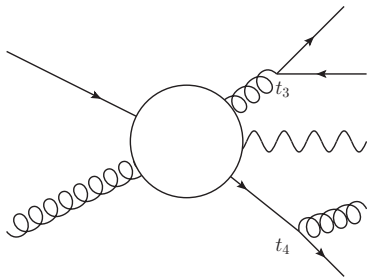

- cluster external particles using inverse parton shower  
→ flavour conscious, initial state aware, probability determined through splitting kernels
- identify a shower history (probabilistically), determine scale  $t_i$  up to predefined  $t_i$
- choose

$$\alpha_s^{n+k}(\mu_R^2) = \alpha_s^k(\mu_{\text{core}}^2) \prod_{i=1}^n \alpha_s(t_i)$$

# QCD multijet merging – identifying a history

## Example: Drell-Yan production in association with jets

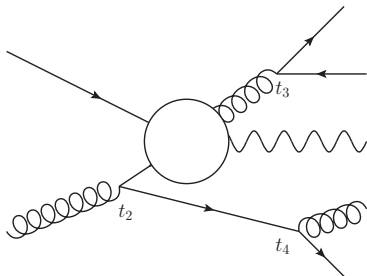

- cluster external particles using inverse parton shower → flavour conscious, initial state aware, probability determined through splitting kernels
- identify a shower history (probabilistically), determine scale  $t_i$  up to predefined  $t_i$
- choose

$$\alpha_s^{n+k}(\mu_R^2) = \alpha_s^k(\mu_{\text{core}}^2) \prod_{i=1}^n \alpha_s(t_i)$$

# QCD multijet merging – identifying a history

## Example: Drell-Yan production in association with jets

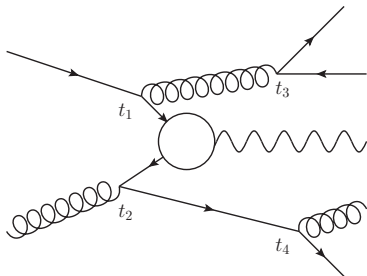

- cluster external particles using inverse parton shower → flavour conscious, initial state aware, probability determined through splitting kernels
- identify a shower history (probabilistically), determine scale  $t_i$  up to predefined  $t_i$
- choose

$$\alpha_s^{n+k}(\mu_R^2) = \alpha_s^k(\mu_{\text{core}}^2) \prod_{i=1}^n \alpha_s(t_i)$$

# QCD multijet merging – identifying a history

## Example: Drell-Yan production in association with jets

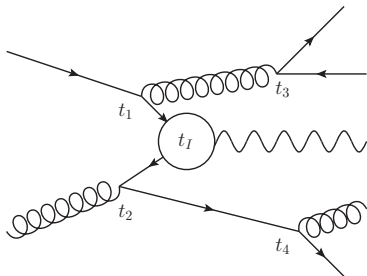

- cluster external particles using inverse parton shower → flavour conscious, initial state aware, probability determined through splitting kernels
- identify a shower history (probabilistically), determine scale  $t_i$  up to predefined  $t_i$
- choose

$$\alpha_s^{n+k}(\mu_R^2) = \alpha_s^k(\mu_{\text{core}}^2) \prod_{i=1}^n \alpha_s(t_i)$$

# QCD multijet merging – identifying a history

## Example: Drell-Yan production in association with jets

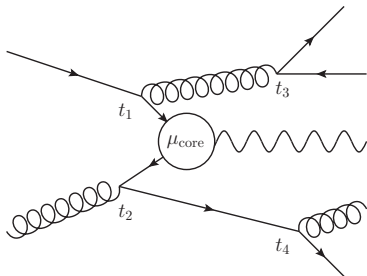

- cluster external particles using inverse parton shower → flavour conscious, initial state aware, probability determined through splitting kernels
- identify a shower history (probabilistically), determine scale  $t_i$  up to predefined  $t_i$
- choose

$$\alpha_s^{n+k}(\mu_R^2) = \alpha_s^k(\mu_{\text{core}}^2) \prod_{i=1}^n \alpha_s(t_i)$$

## QCD multijet merging – identifying a history

ME also provides expression beyond  $t_1$

two types of configuration:  $pp \rightarrow Z + \text{jets}$  and  $pp \rightarrow \text{jets} + Z$

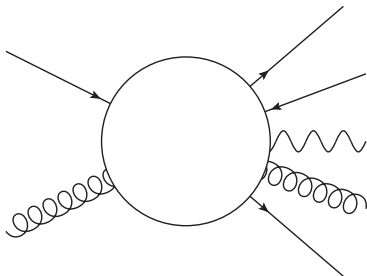

- different core process, naïvely not part of  $pp \rightarrow Z + \text{jets}$  but indistinguishable
- configuration that would have arisen from dijets plus QCD+EW showering
- necessitates EW splitting kernels to calculate splitting probability
- leads to different scale choices and Sudakov factors

## QCD multijet merging – identifying a history

ME also provides expression beyond  $t_1$

two types of configuration:  $pp \rightarrow Z + \text{jets}$  and  $pp \rightarrow \text{jets} + Z$

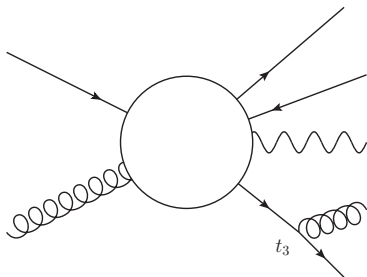

- different core process, naïvely not part of  $pp \rightarrow Z + \text{jets}$  but indistinguishable
- configuration that would have arisen from dijets plus QCD+EW showering
- necessitates EW splitting kernels to calculate splitting probability
- leads to different scale choices and Sudakov factors

## QCD multijet merging – identifying a history

ME also provides expression beyond  $t_1$

two types of configuration:  $pp \rightarrow Z + \text{jets}$  and  $pp \rightarrow \text{jets} + Z$

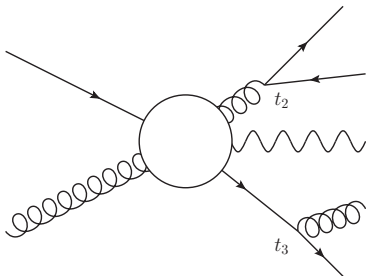

- different core process, naïvely not part of  $pp \rightarrow Z + \text{jets}$  but indistinguishable
- configuration that would have arisen from dijets plus QCD+EW showering
- necessitates EW splitting kernels to calculate splitting probability
- leads to different scale choices and Sudakov factors

## QCD multijet merging – identifying a history

ME also provides expression beyond  $t_1$

two types of configuration:  $pp \rightarrow Z + \text{jets}$  and  $pp \rightarrow \text{jets} + Z$

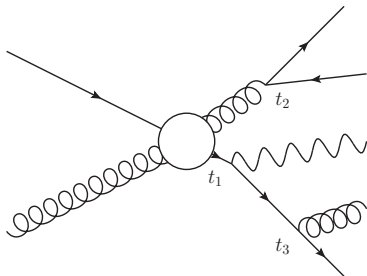

- different core process, naïvely not part of  $pp \rightarrow Z + \text{jets}$  but indistinguishable
- configuration that would have arisen from dijets plus QCD+EW showering
- necessitates EW splitting kernels to calculate splitting probability
- leads to different scale choices and Sudakov factors

## QCD multijet merging – identifying a history

ME also provides expression beyond  $t_I$

two types of configuration:  $pp \rightarrow Z + \text{jets}$  and  $pp \rightarrow \text{jets} + Z$

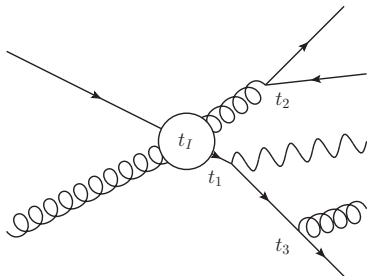

- different core process, naïvely not part of  $pp \rightarrow Z + \text{jets}$  but indistinguishable
- configuration that would have arisen from dijets plus QCD+EW showering
- necessitates EW splitting kernels to calculate splitting probability
- leads to different scale choices and Sudakov factors

# QCD multijet merging – identifying a history

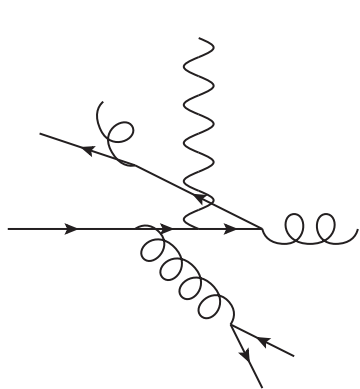

vs.

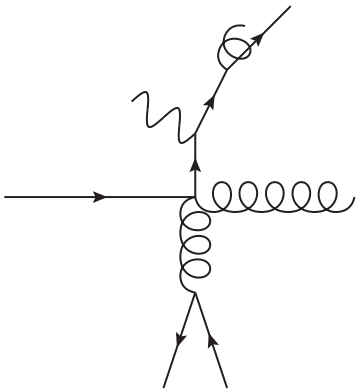

# Importance of electroweak clustering

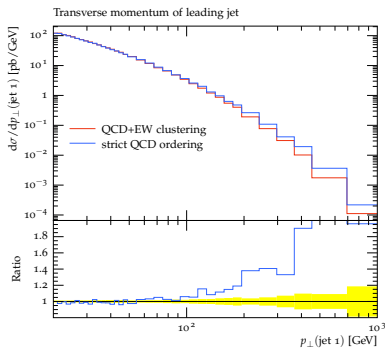
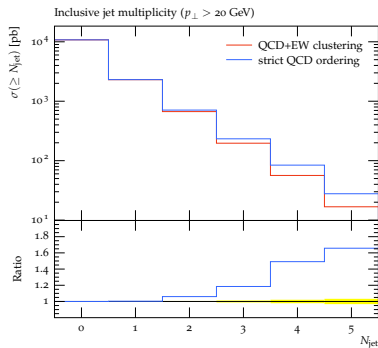

⇒ large impact at high  $p_{\perp}$  and multiplicity



## QCD multijet merging

## Importance of electroweak clustering

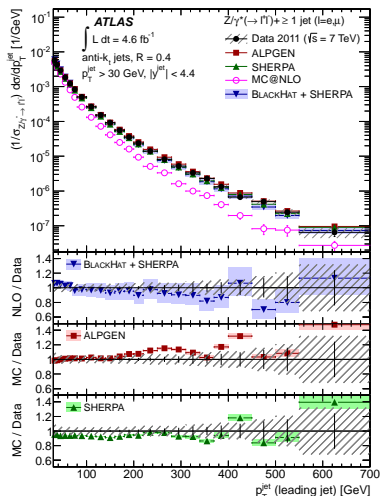
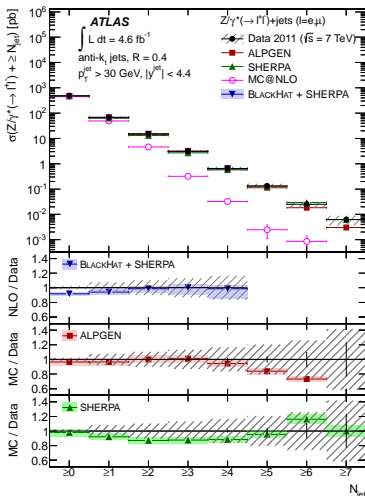

## Inclusion of electroweak corrections

- incorporate approximate electroweak corrections in MEPS@NLO
- using electroweak Sudakov factors

$$\tilde{B}_{n,\text{QCD}\times\text{EW}_{\text{sud}}}(\Phi_n) = \tilde{B}_n(\Phi_n) \Delta_{\text{EW}}(\Phi_n)$$

- using virtual corrections and approx. integrated real corrections

$$\tilde{B}_{n,\text{QCD}+\text{EW}_{\text{virt}}}(\Phi_n) = \tilde{B}_n(\Phi_n) + V_{n,\text{EW}}(\Phi_n) + I_{n,\text{EW}}(\Phi_n) + B_{n,\text{mix}}(\Phi_n)$$

- real QED radiation can be recovered through standard tools (parton shower, YFS resummation)
- simple stand-in for proper QCD+EW matching and merging  
→ validated at fixed order, found to be reliable,  
difference  $\lesssim 5\%$  for observables not driven by real radiation

Results:  $pp \rightarrow \ell^- \bar{\nu} + \text{jets}$ 

Kallweit, Lindert, Maierhöfer, Pozzorini, MS JHEP04(2016)021

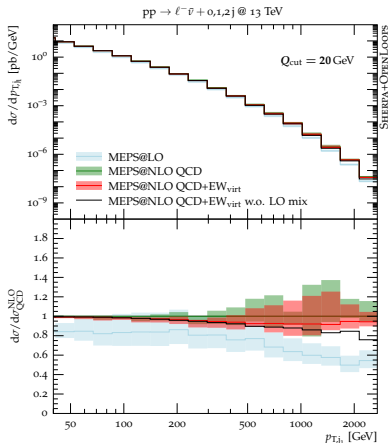
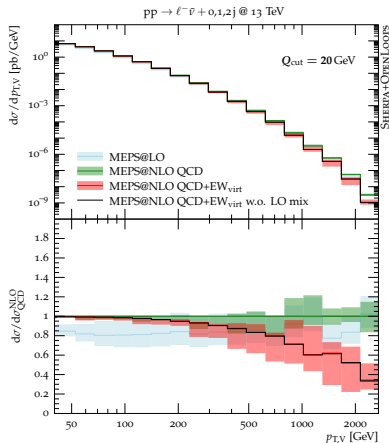

⇒ particle level events including dominant EW corrections

# Electroweak corrections for LHC physics

- 1 Next-to-leading order electroweak corrections
  - Tools and setup
  - Selected results
- 2 Electroweak effects in multijet merging
  - QCD multijet merging
  - Inclusion of electroweak corrections
- 3 Real boson radiation
  - Resummation via EW parton showers
  - Case study: Finding  $W$  bosons inside jets
- 4 Conclusions

## Collinear limit with $E \gg m$

- QED parton showers well known and available in every major shower
- approximation to collinear (vector) boson emission in limit  $E \gg m$ , in dipole language (splitter-spectator pairs):  $f(s) \rightarrow f^{(\prime)}V(s)$

$$d\sigma_{n+V} = d\sigma_n \sum_f \sum_s^{n_{\text{spec}}} dt dz \frac{d\phi}{2\pi} \frac{1}{n_{\text{spec}}} J(t, z) \mathcal{K}_{f(s) \rightarrow f^{(\prime)}V(s)}(t, z)$$

- emitter fermion  $f$ , suitable spectator  $s$
- flavour change  $f \rightarrow f'$  in case of  $W$  emissions
- IS kernels contain ratio of PDFs (change in  $x, Q, \text{flavour}$ )
- similar ansatz with diff. kernels in [Christiansen, Sjöstrand JHEP04\(2014\)115](#)
- same ansatz as used for clustering in multijet merging

# Splitting kernels

Denner, Hebenstreit unpublished

- use Denner-Hebenstreit expressions modified into CDST form

$$\mathcal{K}_{f(s) \rightarrow f' W(s)}(t, z) = \frac{\alpha}{2\pi t} \left[ f_W c_{\perp}^W \tilde{V}_{f(s) \rightarrow f' b(s)}^{\text{CDST}}(t, z) + f_h c_L^W \frac{1}{2} (1 - z) \right]$$

$$\mathcal{K}_{f(s) \rightarrow f Z(s)}(t, z) = \frac{\alpha}{2\pi t} \left[ f_Z c_{\perp}^Z \tilde{V}_{f(s) \rightarrow f b(s)}^{\text{CDST}}(t, z) + f_h c_L^Z \frac{1}{2} (1 - z) \right]$$

with

$$c_{\perp}^W = s_{\text{eff}} \frac{1}{2s_W^2} |V_{ff'}|^2, \quad c_{\perp}^Z = s_{\text{eff}} \frac{s_W^2}{c_W^2} Q_f^2 + (1 - s_{\text{eff}}) \frac{(I_f^3 - s_W^2 Q_f)^2}{s_W^2 c_W^2},$$

$$c_L^W = \frac{1}{2s_W^2} |V_{ff'}|^2 \left[ s_{\text{eff}} \frac{m_{f'}^2}{m_W^2} + (1 - s_{\text{eff}}) \frac{m_f^2}{m_W^2} \right], \quad c_L^Z = \frac{I_f^3}{s_W^2} \frac{m_f^2}{m_W^2},$$

- couplings  $ff^{(\prime)} V$  depend on spin of  $f$ , but standard parton showers are spin averaged (no spin information)
- process dependent average spin of fermion line  $s_{\text{eff}}$   
 $\Rightarrow pp \rightarrow jj: s_{\text{eff}} = \frac{1}{2}, pp \rightarrow W: s_{\text{eff}} = 1$ , undefined in general
- factors  $f_W, f_Z, f_h$  modify couplings to test sensitivity

Krauss, Petrov, MS, Spannowsky [Phys.Rev.D89\(2014\)114006](#)

## Can we see radiated $W$ bosons inside jets at the LHC (14 TeV)?

- need high- $p_{\perp}$  jets to produce real  $W$  bosons at sufficient rate
- need high- $p_{\perp}$  jets to satisfy assumption  $E \gg m$

### Boosted analysis:

- isolated leptons ( $p_{\perp} > 25$  GeV,  $|\eta| < 2.5$ , max. 10% in  $\Delta R = 0.2$ )
- find jets (anti- $k_{\perp}$ ,  $R = 1.5$ ,  $p_{\perp} > 200$  GeV) on remainder
- two cases: no isolated leptons  $\Rightarrow$  hadronic analysis  
one isolated lepton  $\Rightarrow$  leptonic analysis
- require further two jets with  $p_{\perp} > 500, 750, 1000$  GeV to drive  $W$  radiation into collinear region

## Hadronic analysis

- recluster fat jets into C/A ( $R = 0.3$ ,  $p_{\perp} > 20$  GeV) microjets
  - discard leading microjet as likely from leading quark
  - use  $m_{23}$  as em. gluons tend to be softer than decay prod. of em.  $W$
  - accept candidate if  $m_{23} \in [70, 86]$  GeV
- ⇒ large, but continuous QCD background, clear signal shape
- ⇒ more  $W$  emissions with high  $p_{\perp}$ , but peak shifts

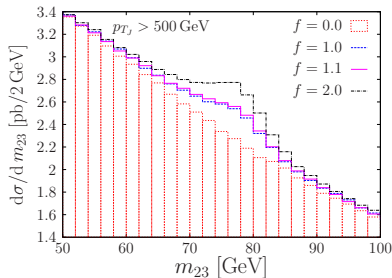

## Hadronic analysis

- recluster fat jets into C/A ( $R = 0.3$ ,  $p_{\perp} > 20$  GeV) microjets
  - discard leading microjet as likely from leading quark
  - use  $m_{23}$  as em. gluons tend to be softer than decay prod. of em.  $W$
  - accept candidate if  $m_{23} \in [70, 86]$  GeV
- ⇒ large, but continuous QCD background, clear signal shape
- ⇒ more  $W$  emissions with high  $p_{\perp}$ , but peak shifts

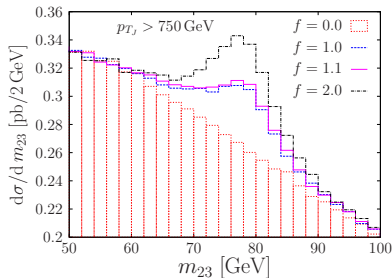

## Hadronic analysis

- recluster fat jets into C/A ( $R = 0.3$ ,  $p_{\perp} > 20$  GeV) microjets
  - discard leading microjet as likely from leading quark
  - use  $m_{23}$  as em. gluons tend to be softer than decay prod. of em.  $W$
  - accept candidate if  $m_{23} \in [70, 86]$  GeV
- ⇒ large, but continuous QCD background, clear signal shape
- ⇒ more  $W$  emissions with high  $p_{\perp}$ , but peak shifts

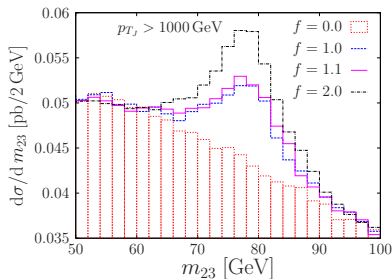

## Leptonic analysis

- exactly one isolated lepton
- require  $\cancel{E}_T > 50$  GeV
- reconstruct

$$m_T = \sqrt{2E_{T_l} \cancel{E}_T (1 - \cos \theta)}$$

- accept candidate if  $m_T \in [60, 100]$  GeV

- ⇒ provides good background rejection
- ⇒ loose some sensitivity for higher fat jet  $p_\perp$  as isolation is compromised for more collinear  $W$  emissions

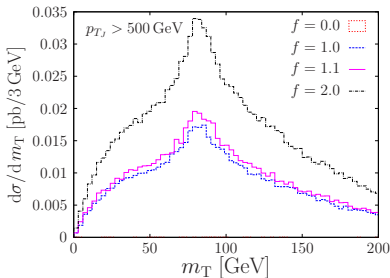

## Leptonic analysis

- exactly one isolated lepton
- require  $\cancel{E}_T > 50$  GeV
- reconstruct

$$m_T = \sqrt{2E_{T_l} \cancel{E}_T (1 - \cos \theta)}$$

- accept candidate if  $m_T \in [60, 100]$  GeV

⇒ provides good background rejection

⇒ loose some sensitivity for higher fat jet  $p_\perp$  as isolation is compromised for more collinear  $W$  emissions

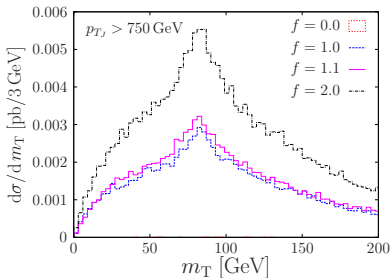

## Leptonic analysis

- exactly one isolated lepton
- require  $\cancel{E}_T > 50$  GeV
- reconstruct

$$m_T = \sqrt{2E_{T_l} \cancel{E}_T (1 - \cos \theta)}$$

- accept candidate if  $m_T \in [60, 100]$  GeV

- ⇒ provides good background rejection
- ⇒ loose some sensitivity for higher fat jet  $p_\perp$  as isolation is compromised for more collinear  $W$  emissions

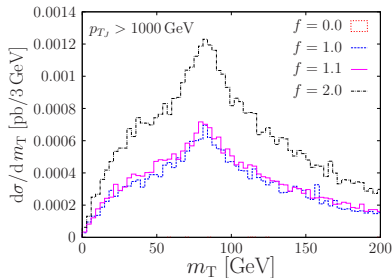

# NLO EW predictions for $\Delta R(\mu, j_1)$

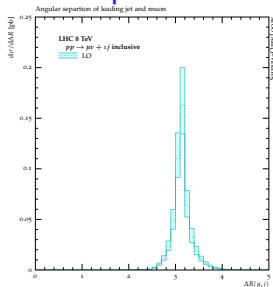

LHC@8TeV,  $p_{\perp}^1 > 500$  GeV, central  $\mu$  and jet

- LO  $pp \rightarrow Wj$  with  $\Delta\phi(\mu, j) \approx \pi$ 
  - NLO corrections neg. in peak
  - large  $pp \rightarrow Wjj$  component opening PS
  - subleading Born imp. at large  $\Delta R$
  - describe  $pp \rightarrow Wjj$  @ NLO, use  $p_{\perp}^2 > 20$  GeV
  - pos. NLO QCD,  $\sigma_{\text{NLO}}/\sigma_{\text{LO}} \sim \text{flat}$
  - subleading Born contribs positive
  - sub<sup>2</sup>leading Born (diboson process) contribs positive
    - possible double counting with BG
    - merge using exclusive sums

## NLO EW predictions for $\Delta R(\mu, j_1)$

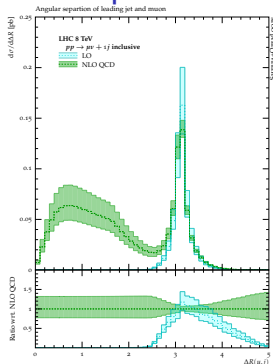

LHC@8TeV,  $p_{\perp}^j > 500$  GeV, central  $\mu$  and jet

- LO  $pp \rightarrow Wj$  with  $\Delta\phi(\mu, j) \approx \pi$
- NLO corrections neg. in peak  
large  $pp \rightarrow Wjj$  component opening PS
- subleading Born imp. at large  $\Delta R$
- describe  $pp \rightarrow Wjj$  @ NLO,  
use  $p_{\perp}^j > 20$  GeV
- pos. NLO QCD,  $\Delta R$  NLO EW  $\sim$  flat
- subleading Born contribs positive
- sub<sup>2</sup>leading Born (diboson process)  
contribs positive  
→ possible double counting with BG
- merge using exclusive sums

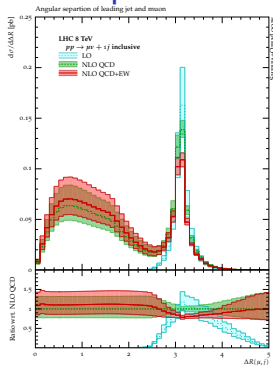
Case study: Finding  $W$  bosons inside jetsNLO EW predictions for  $\Delta R(\mu, j_1)$ 

LHC@8TeV,  $p_{\perp}^j > 500$  GeV, central  $\mu$  and jet

- LO  $pp \rightarrow Wj$  with  $\Delta\phi(\mu, j) \approx \pi$
- NLO corrections neg. in peak  
large  $pp \rightarrow Wjj$  component opening PS
  - subleading Born imp. at large  $\Delta R$
  - describe  $pp \rightarrow Wjj$  @ NLO, use  $p_{\perp}^j > 20$  GeV
  - pos. NLO QCD,  $\sim$  flat
  - subleading Born contribs positive
  - sub<sup>2</sup>leading Born (diboson process) contribs positive  
→ possible double counting with BG
  - merge using exclusive sums

## NLO EW predictions for $\Delta R(\mu, j_1)$

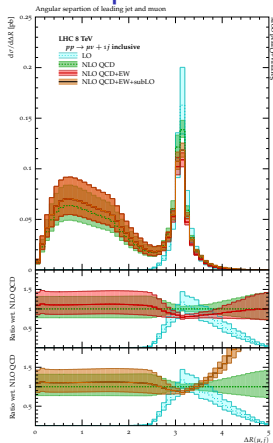

LHC@8TeV,  $p_{\perp}^j > 500$  GeV, central  $\mu$  and jet

- LO  $pp \rightarrow Wj$  with  $\Delta\phi(\mu, j) \approx \pi$
- NLO corrections neg. in peak  
large  $pp \rightarrow Wjj$  component opening PS
- subleading Born imp. at large  $\Delta R$ 
  - describe  $pp \rightarrow Wjj$  @ NLO,  
use  $p_{\perp}^j > 20$  GeV
  - pos. NLO QCD,  $\sim \text{flat}$
  - subleading Born contribs positive
  - sub<sup>2</sup>leading Born (diboson process)  
contribs positive  
→ possible double counting with BG
- merge using exclusive sums

## NLO EW predictions for $\Delta R(\mu, j_1)$

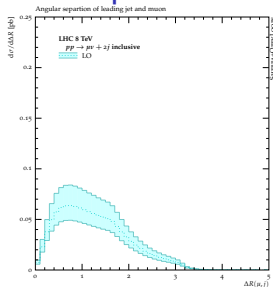

LHC@8TeV,  $p_{\perp}^{j_1} > 500$  GeV, central  $\mu$  and jet

- LO  $pp \rightarrow Wj$  with  $\Delta\phi(\mu, j) \approx \pi$
- NLO corrections neg. in peak  
large  $pp \rightarrow Wjj$  component opening PS
- subleading Born imp. at large  $\Delta R$
- describe  $pp \rightarrow Wjj$  @ NLO,  
use  $p_{\perp}^{j_2} > 20$  GeV

- pos. NLO QCD,  $\Delta R(\mu, j_1) \sim \text{flat}$

- subleading Born contris positive

- sub<sup>2</sup>leading Born (diboson process)  
contris positive

→ possible double counting with BG

- merge using exclusive sums

# NLO EW predictions for $\Delta R(\mu, j_1)$

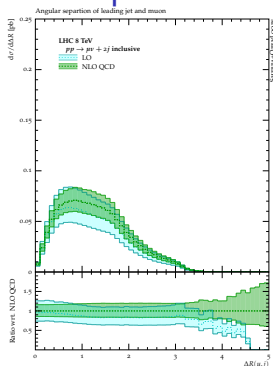

LHC@8TeV,  $p_{\perp}^j > 500$  GeV, central  $\mu$  and jet

- LO  $pp \rightarrow Wj$  with  $\Delta\phi(\mu, j) \approx \pi$
- NLO corrections neg. in peak  
large  $pp \rightarrow Wjj$  component opening PS
- subleading Born imp. at large  $\Delta R$
- describe  $pp \rightarrow Wjj$  @ NLO,  
use  $p_{\perp}^j > 20$  GeV
- pos. NLO QCD, neg. NLO EW,  $\sim$  flat
- subleading Born contribs positive
- sub<sup>2</sup>leading Born (diboson process)  
contribs positive  
→ possible double counting with BG
- merge using exclusive sums

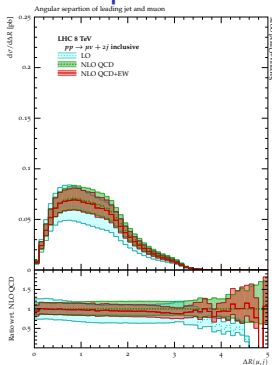
Case study: Finding  $W$  bosons inside jetsNLO EW predictions for  $\Delta R(\mu, j_1)$ 

LHC@8TeV,  $p_{\perp}^1 > 500$  GeV, central  $\mu$  and jet

- LO  $pp \rightarrow Wj$  with  $\Delta\phi(\mu, j) \approx \pi$
- NLO corrections neg. in peak  
large  $pp \rightarrow Wjj$  component opening PS
- subleading Born imp. at large  $\Delta R$
- describe  $pp \rightarrow Wjj$  @ NLO,  
use  $p_{\perp}^2 > 20$  GeV
- pos. NLO QCD, neg. NLO EW,  $\sim$  flat
  - subleading Born contribs positive
  - sub<sup>2</sup>leading Born (diboson process)  
contribs positive  
→ possible double counting with BG
  - merge using exclusive sums

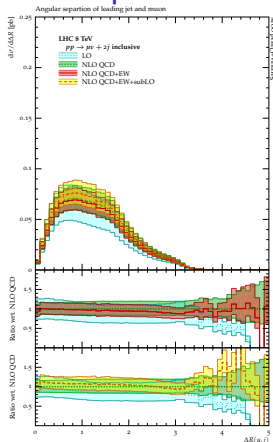
Case study: Finding  $W$  bosons inside jetsNLO EW predictions for  $\Delta R(\mu, j_1)$ 

LHC@8TeV,  $p_{\perp}^{j_1} > 500$  GeV, central  $\mu$  and jet

- LO  $pp \rightarrow Wj$  with  $\Delta\phi(\mu, j) \approx \pi$
- NLO corrections neg. in peak  
large  $pp \rightarrow Wjj$  component opening PS
- subleading Born imp. at large  $\Delta R$
- describe  $pp \rightarrow Wjj$  @ NLO,  
use  $p_{\perp}^{j_2} > 20$  GeV
- pos. NLO QCD, neg. NLO EW,  $\sim$  flat
- subleading Born contribs positive
- sub<sup>2</sup>leading Born (diboson process)  
contribs positive  
→ possible double counting with BG
- merge using exclusive sums

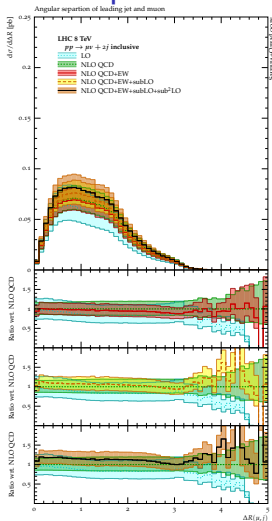
Case study: Finding  $W$  bosons inside jetsNLO EW predictions for  $\Delta R(\mu, j_1)$ 

LHC@8TeV,  $p_{\perp}^{j_1} > 500$  GeV, central  $\mu$  and jet

- LO  $pp \rightarrow Wj$  with  $\Delta\phi(\mu, j) \approx \pi$
- NLO corrections neg. in peak  
large  $pp \rightarrow Wjj$  component opening PS
- subleading Born imp. at large  $\Delta R$
- describe  $pp \rightarrow Wjj$  @ NLO,  
use  $p_{\perp}^{j_2} > 20$  GeV
- pos. NLO QCD, neg. NLO EW,  $\sim$  flat
- subleading Born contribs positive
- sub<sup>2</sup>leading Born (diboson process)  
contribs positive  
→ possible double counting with BG
- merge using exclusive sums

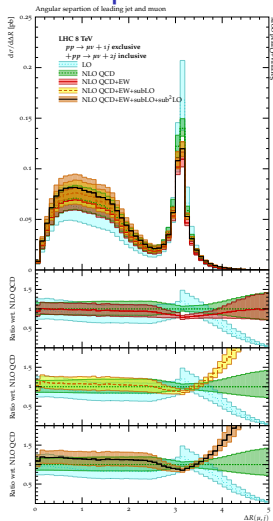
Case study: Finding  $W$  bosons inside jetsNLO EW predictions for  $\Delta R(\mu, j_1)$ 

LHC@8TeV,  $p_{\perp}^{j_1} > 500$  GeV, central  $\mu$  and jet

- LO  $pp \rightarrow Wj$  with  $\Delta\phi(\mu, j) \approx \pi$
- NLO corrections neg. in peak  
large  $pp \rightarrow Wjj$  component opening PS
- subleading Born imp. at large  $\Delta R$
- describe  $pp \rightarrow Wjj$  @ NLO,  
use  $p_{\perp}^{j_2} > 20$  GeV
- pos. NLO QCD, neg. NLO EW,  $\sim$  flat
- subleading Born contribs positive
- sub<sup>2</sup>leading Born (diboson process)  
contribs positive  
→ possible double counting with BG
- merge using exclusive sums

## Conclusions

- electroweak effects are important at LHC at 13 TeV, FCC etc.
- become large whenever the scale is large compared the electroweak scale
- can be incorporated in multijet merging to improve description in those regions
- proper QCD+EW merging methods still needs to be defined
- automation of NLO EW follows on the heels of NLO QCD
  - much more care with consistent schemes and order counting
  - automated in SHERPA/MUNICH +OPENLOOPS
  - ⇒ included in next major SHERPA release
- EW parton showers suffer from strong spin dependence of  $W/Z$  emission as parton showers are usually do not have spin information
  - ⇒ not included in SHERPA public release

Thank you for your attention!

# Backup

# Example: Forward-backward asymmetry @ Tevatron

Höche, Huang, Luisoni, MS, Winter Phys.Rev.D88(2013)1,014040

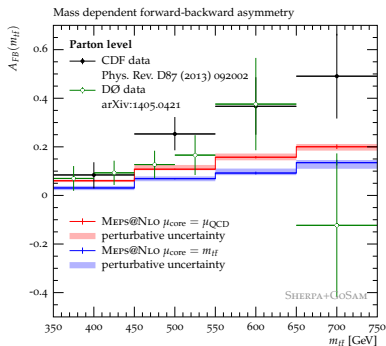
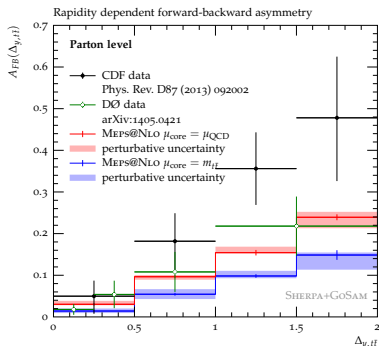

Chose two different  $\mu_{\text{core}}$  → largest impact

Electroweak histories not an issue, but merging works nicely

# Recent NNLO+NNLL results: Forward-backward asymmetry @ Tevatron

Czakon, Fiedler, Mitov arXiv:1411.3007

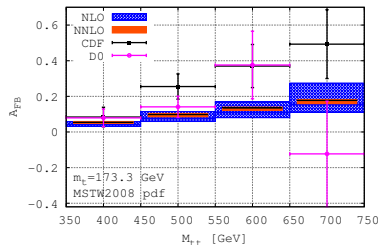
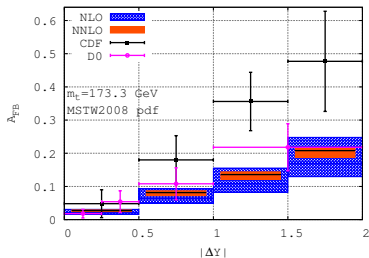

MEPS@NLO result very well reproduced by higher order calculation

# Merging systematics: $pp \rightarrow \ell^- \bar{\nu} + \text{jets}$

Kallweit, Lindert, Maierhöfer, Pozzorini, MS JHEP04(2016)021

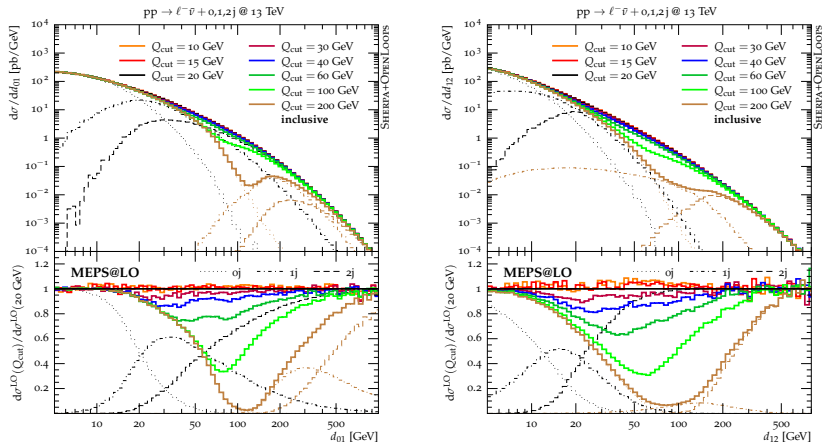

⇒ dead zones in incl. obs. if  $Q_{\text{cut}}$  too high

Merging systematics:  $pp \rightarrow \ell^- \bar{\nu} + \text{jets}$ 

Kallweit, Lindert, Maierhöfer, Pozzorini, MS JHEP04(2016)021

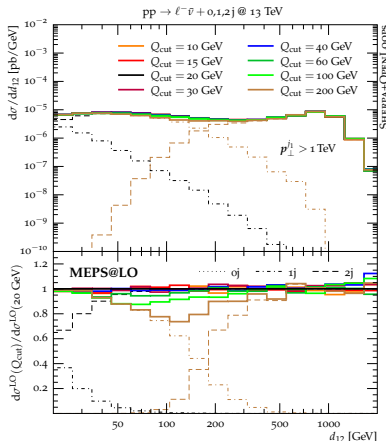
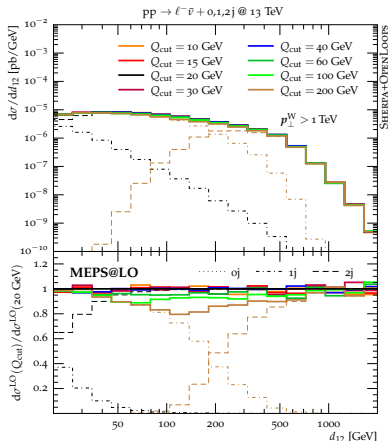

⇒ dead zones in incl. obs. if  $Q_{\text{cut}}$  too high



# Merging systematics: $pp \rightarrow \ell^- \bar{\nu} + \text{jets}$

Kallweit, Lindert, Maierhöfer, Pozzorini, MS JHEP04(2016)021

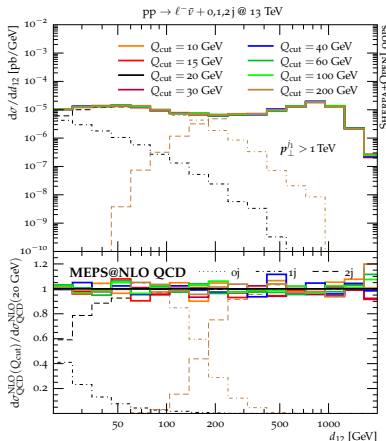
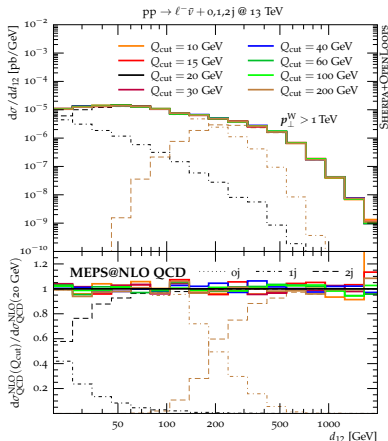

⇒ dead zones in incl. obs. if  $Q_{\text{cut}}$  too high

# Merging systematics: $pp \rightarrow \ell^- \bar{\nu} + \text{jets}$

Kallweit, Lindert, Maierhöfer, Pozzorini, MS JHEP04(2016)021

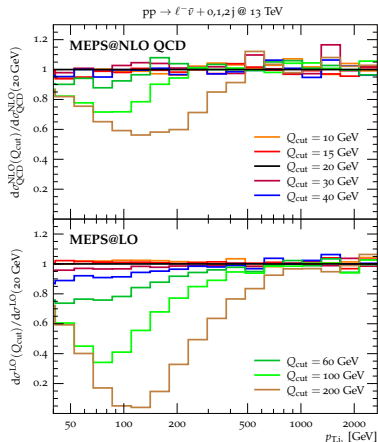
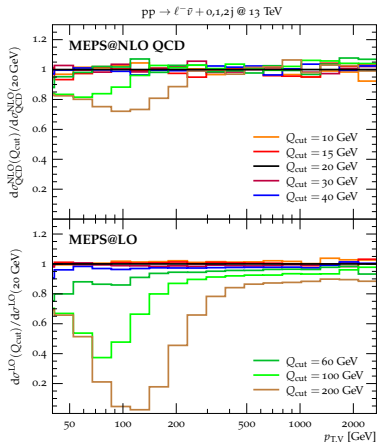

⇒ TeV region stable ( $\lesssim 5\%$ ),  $Q_{\text{cut}} = 20 \text{ GeV}$  suitable for whole range

## Hadronic analysis

- use event shape variables on microjets of reconstructed  $W$  candidate to enhance S/B, e.g. ellipticity

$$\hat{t} = \frac{T_{\min}}{T_{\max}}$$

→ small when radiation pattern is 1D ( $W \rightarrow q\bar{q}$ )

- fat jet  $p_{\perp} > 750$  GeV optimal best balance between cross section and emission rate
- ⇒ additional discrimination

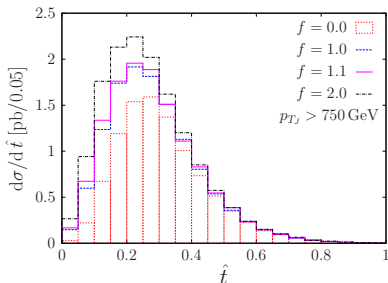

# Hadronic analysis

Can we distinguish between  $f = 1$  and  $f = 2$   
(simplified version of: How accurate can we measure the coupling?)

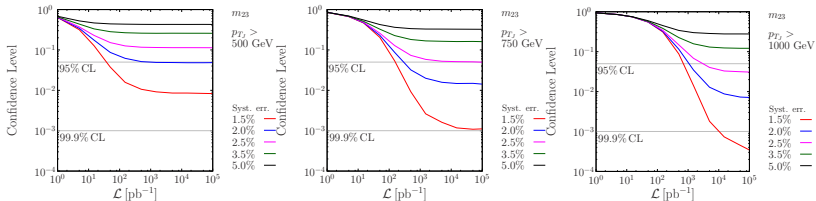

- signal:  $f = 2$ , background:  $f = 1$  (SM)
- moderate sensitivity even under ideal conditions  
benefits from larger emission at large  $p_{\perp}$  despite smaller cross section

# Leptonic analysis

Can we distinguish between  $f = 1$  and  $f = 1.1$ ?  
(simplified version of: How accurate can we measure the coupling?)

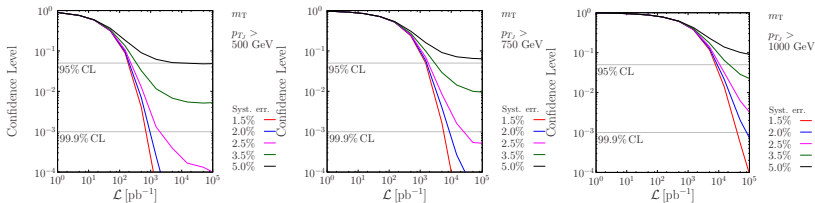

- signal:  $f = 1.1$ , background:  $f = 1.0$  (SM)
- improved sensitivity, despite small cross sections, benefits from ideal background rejection